

**PACKAGE DIMENSIONS**

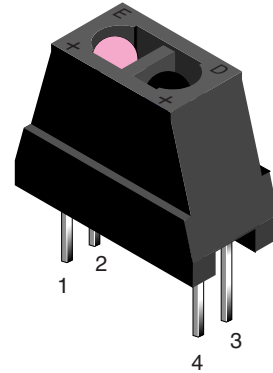

**SCHEMATIC**

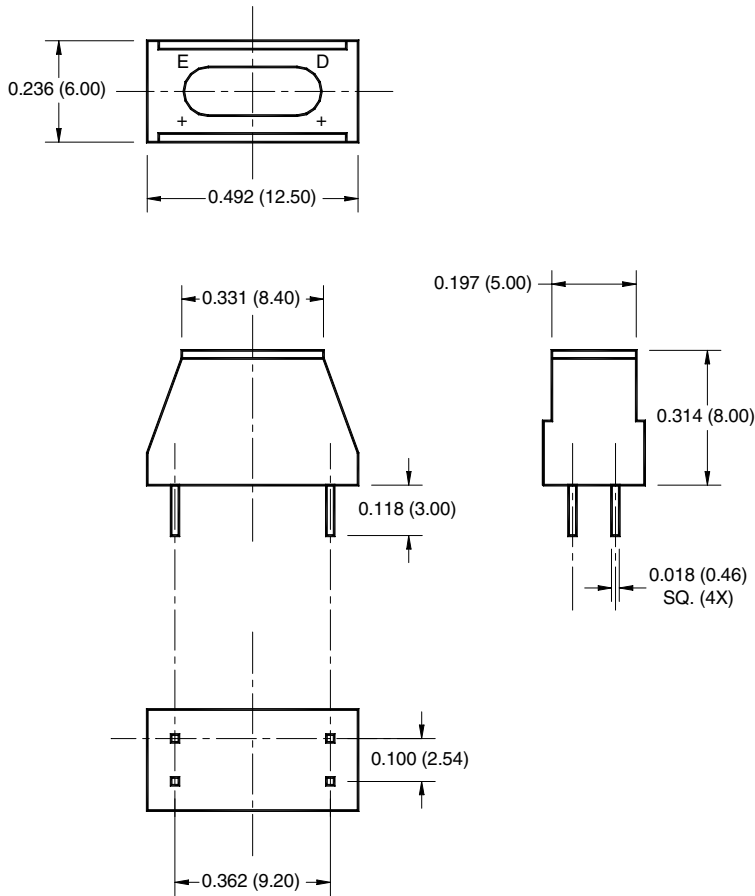
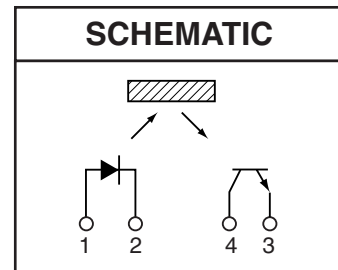

**NOTES:**

1. Dimensions for all drawings are in inches.
2. Tolerance of  $\pm .010$  on all non-nominal dimensions unless otherwise specified.

**DESCRIPTION**

The QRE00034 reflective object sensor consists of an infrared emitting diode and an NPN phototransistor mounted side by side on a converging optical axis in a black housing. The phototransistor responds to radiation from the emitting diode only when a reflective object passes in its field of view.

**FEATURES**

- Phototransistor output
- No contact surface sensing
- Daylight filter on the sensor
- Emitter  $\lambda = 940$  nm

**ABSOLUTE MAXIMUM RATINGS** ( $T_A = 25^\circ\text{C}$  unless otherwise specified)

Parameter	Symbol	Rating	Units
Operating Temperature	$T_{OPR}$	-40 to +85	$^\circ\text{C}$
Storage Temperature	$T_{STG}$	-40 to +85	$^\circ\text{C}$
Soldering Temperature (Iron) <sup>(2,3,4)</sup>	$T_{SOL-I}$	240 for 5 sec	$^\circ\text{C}$
Soldering Temperature (Flow) <sup>(2,3)</sup>	$T_{SOL-F}$	260 for 10 sec	$^\circ\text{C}$
<b>EMITTER</b>			
Continuous Forward Current	$I_F$	50	mA
Reverse Voltage	$V_R$	5	V
Peak Forward Current	$I_{FP}$	1	A
Power Dissipation <sup>(1)</sup>	$P_D$	100	mW
<b>SENSOR</b>			
Collector-Emitter Voltage	$V_{CEO}$	30	V
Power Dissipation <sup>(1)</sup>	$P_D$	100	mW

**ELECTRICAL / OPTICAL CHARACTERISTICS** ( $T_A = 25^\circ\text{C}$ )

PARAMETER	TEST CONDITIONS	SYMBOL	MIN	TYP	MAX	UNITS
<b>EMITTER</b>						
Forward Voltage	$I_F = 20\text{ mA}$	$V_F$	—	—	1.7	V
Reverse Current	$V_R = 5\text{ V}$	$I_R$	—	—	100	$\mu\text{A}$
Peak Emission Wavelength	$I_F = 20\text{ mA}$	$\lambda_{PE}$	—	940	—	nm
<b>SENSOR</b>						
Dark Current	$V_{CE} = 10\text{ V}, I_F = 0\text{ mA}$	$I_D$	—	—	100	nA
Peak Sensitivity Wavelength	$V_{CE} = 5\text{ V}$	$\lambda_{PS}$	—	880	—	nm
<b>COUPLED</b>						
Collector Current	$I_F = 20\text{ mA}, V_{CE} = 10\text{ V}^{(6,7)}$	$I_{C(ON)}$	0.16	—	2.00	mA
Collector Emitter Saturation Voltage	$I_F = 20\text{ mA}, I_C = 0.5\text{ mA}$	$V_{CE(SAT)}$	—	—	0.4	V
Rise Time	$V_{CE} = 5\text{ V}, R_L = 100\ \Omega$	$t_r$	—	10	—	$\mu\text{s}$
Fall Time	$I_{C(ON)} = 5\text{ mA}$	$t_f$	—	50	—	$\mu\text{s}$

**NOTES**

- Derate power dissipation linearly 1.33 mW/ $^\circ\text{C}$  above 25 $^\circ\text{C}$ .
- RMA flux is recommended.
- Methanol or isopropyl alcohols are recommended as cleaning agents.
- Soldering iron tip at 1/16" (1.6mm) from housing.
- Pulse conditions:  $t_p = 10\ \mu\text{s}$ ;  $T = 1\text{ ms}$ .
- Measured as an Eastman Kodak neutral white test card with 90% diffused reflectance as a reflecting surface.
- 0.160" (4 mm) distance from sensor face to reflector surface.

**TYPICAL PERFORMANCE CURVES**

**Fig. 1 Normalized Collector Current vs. Distance**

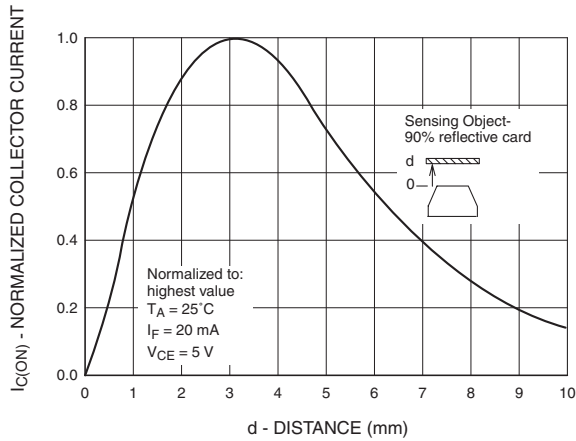

**Fig. 2 Forward Current vs. Forward Voltage**

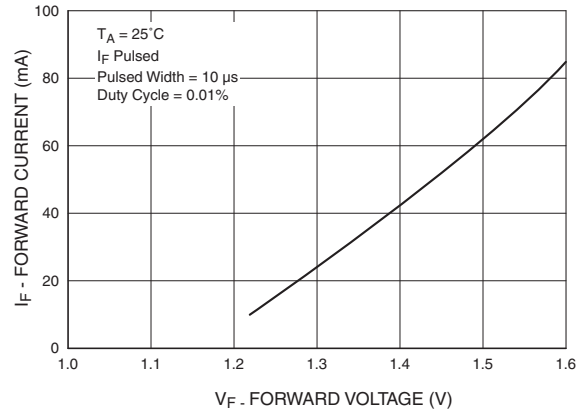

**Fig. 3 Normalized Collector Current vs. Angle Deviation**

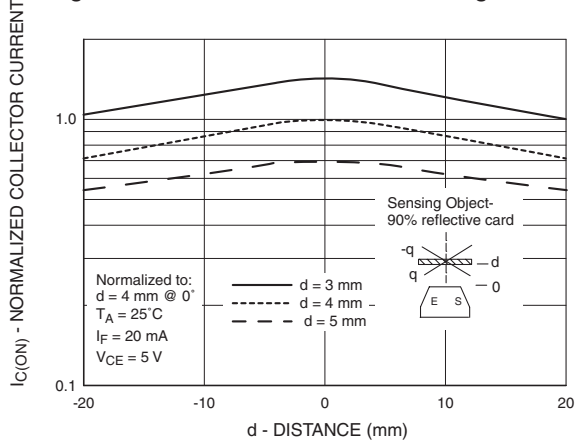

**Fig. 4 Collector Current vs. Forward Current**

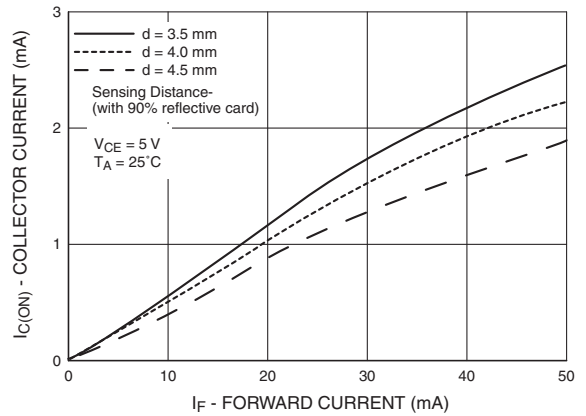

**Fig. 5 Normalized Collector Current vs. Ambient Temperature**

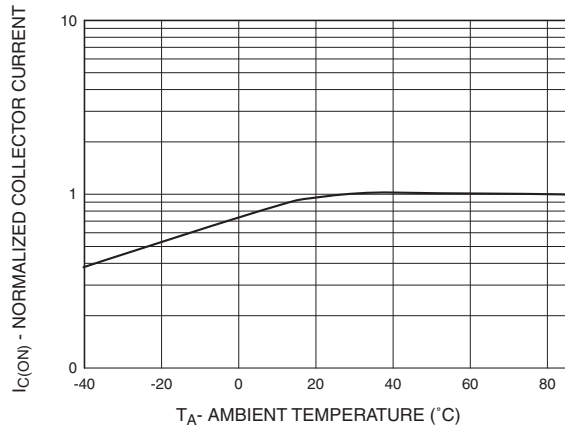

**Fig. 6 Rise and Fall Time vs. Collector Current**

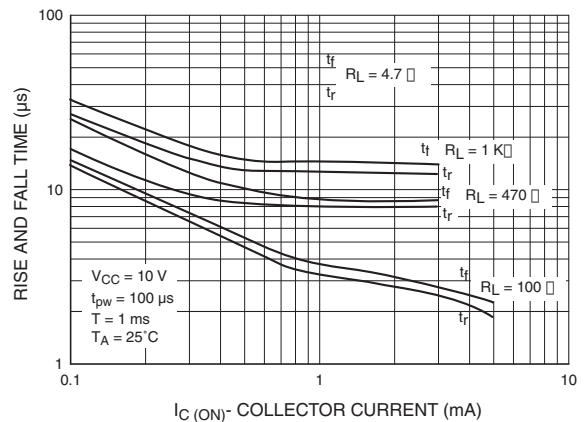

**Fig. 7 Collector Current vs. Collector to Emitter Voltage**

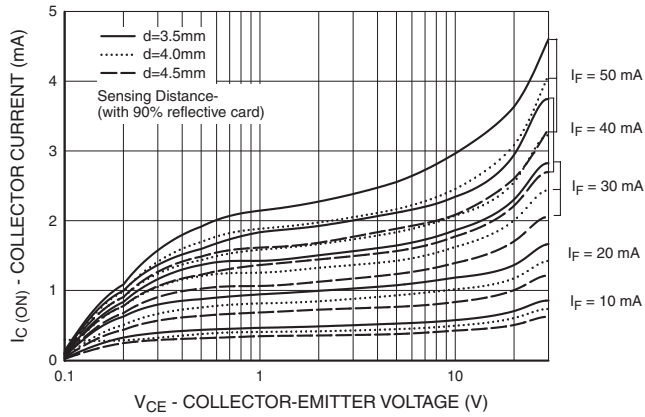

**Fig. 8 Collector Emitter Dark Current vs. Forward Current**

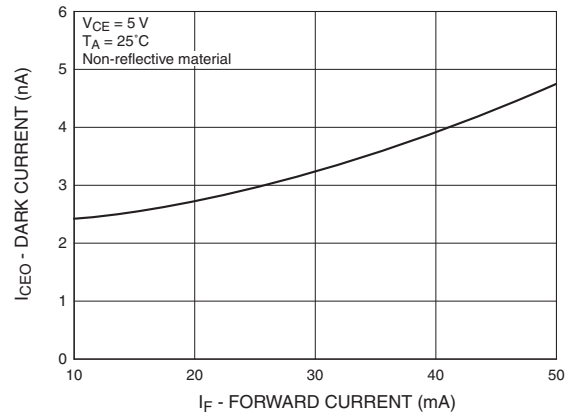

**Fig. 9 Forward Voltage vs. Ambient Temperature**

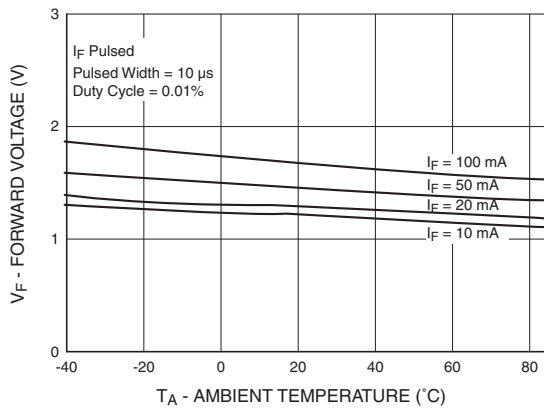

**Fig. 10 Normalized Collector Current vs. Distance  $d_2$**

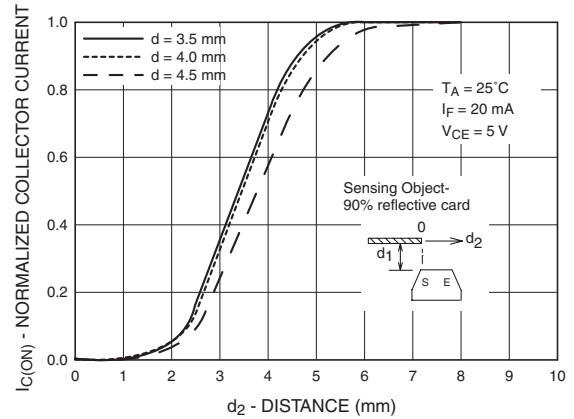

**Fig. 11 Normalized Collector Current vs. Distance  $d_2$**

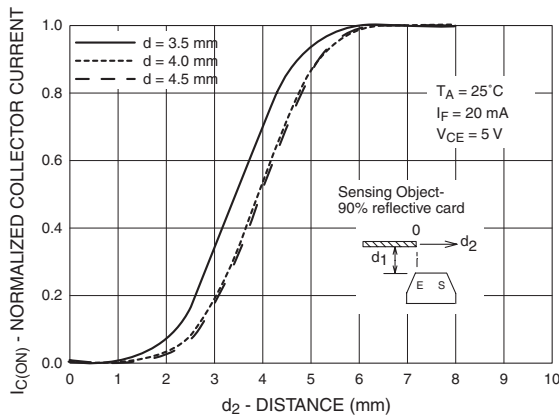

**Fig. 12 Normalized Collector Current vs. Distance  $d_2$**

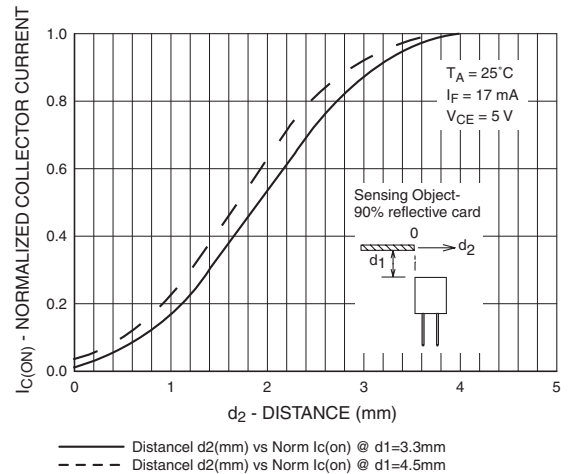

**ANTISTATIC PLASTIC TUBE PACKING (50 PCS PER TUBE)**

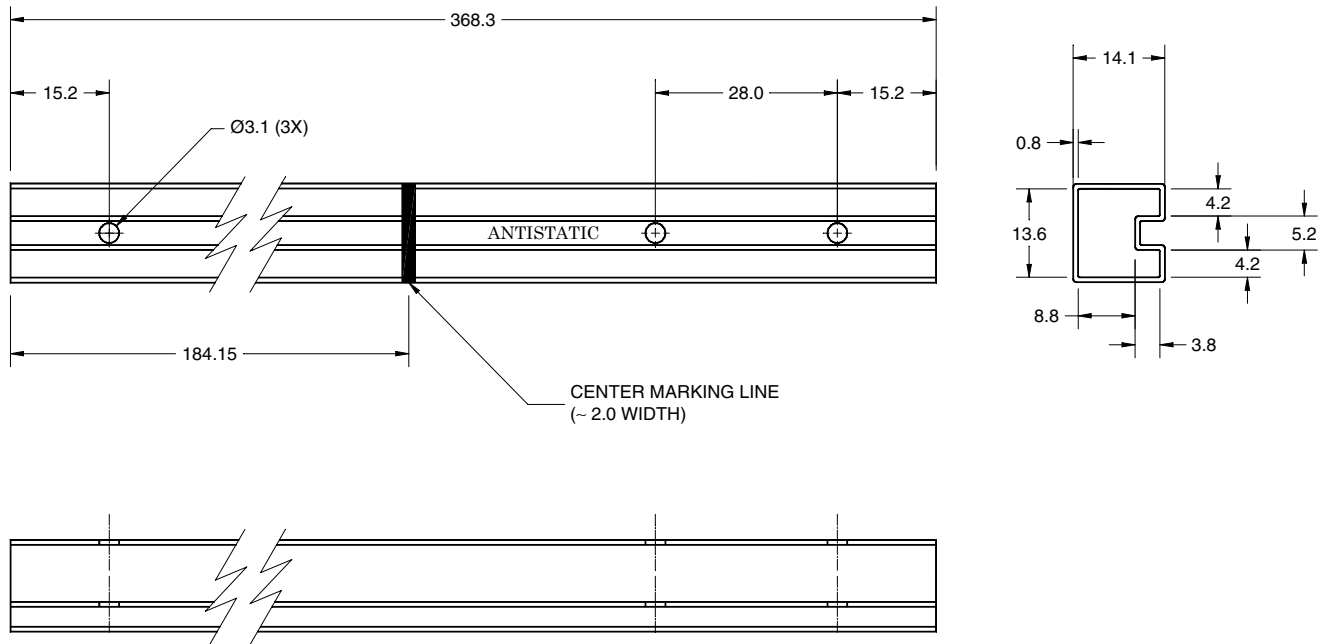

**NOTES**

1. Dimensions: All dimensions are in mm.
2. Color: Clear (Transparent).
3. Antistatic resistivity level:  $10^5 - 10^{12}$  Ohm/sq.
4. Tolerance:  $\pm 0.25$  inches, unless otherwise specified.

### DISCLAIMER

FAIRCHILD SEMICONDUCTOR RESERVES THE RIGHT TO MAKE CHANGES WITHOUT FURTHER NOTICE TO ANY PRODUCTS HEREIN TO IMPROVE RELIABILITY, FUNCTION OR DESIGN. FAIRCHILD DOES NOT ASSUME ANY LIABILITY ARISING OUT OF THE APPLICATION OR USE OF ANY PRODUCT OR CIRCUIT DESCRIBED HEREIN; NEITHER DOES IT CONVEY ANY LICENSE UNDER ITS PATENT RIGHTS, NOR THE RIGHTS OF OTHERS.

### LIFE SUPPORT POLICY

FAIRCHILD'S PRODUCTS ARE NOT AUTHORIZED FOR USE AS CRITICAL COMPONENTS IN LIFE SUPPORT DEVICES OR SYSTEMS WITHOUT THE EXPRESS WRITTEN APPROVAL OF THE PRESIDENT OF FAIRCHILD SEMICONDUCTOR CORPORATION. As used herein:

1. Life support devices or systems are devices or systems which, (a) are intended for surgical implant into the body, or (b) support or sustain life, and (c) whose failure to perform when properly used in accordance with instructions for use provided in labeling, can be reasonably expected to result in a significant injury of the user.
2. A critical component in any component of a life support device or system whose failure to perform can be reasonably expected to cause the failure of the life support device or system, or to affect its safety or effectiveness.